



# Clover Mobile

## Feature Guide



English	1
Deutsch	14
Español	28
Français	42
Italiano	56
Nederlands	70
Polski	84

This guide describes  
Clover Mobile's hardware  
and software features.

We are continuously  
improving our software.  
To see the latest version  
of this guide, visit  
[clover.com/setup](https://clover.com/setup).

In Europe, visit [eu.clover.com/setup](https://eu.clover.com/setup)

## What's included



Clover Mobile



Clover Clip



USB wall charger



USB cable

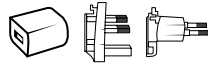

2 international plug adapters  
(Europe only)



SIM door eject pin  
(only for 3G)



SIM card tray  
(only for 3G)

---

### Optional Accessories



Clover Mobile Dock



Clover Mobile Printer

## About Clover Mobile

Clover Mobile is a powerful Point of Sale device that goes wherever you want in your store (and beyond). Its integrated hardware lets you take payments, scan inventory, and run your day-to-day business operations where you choose.

Whether it is in your hand or on the countertop or wall, Clover Mobile securely enables credit and debit card transactions via swipe (MSR), insert (EMV Chip), or tap (EMV Contactless).

Clover Mobile is estimated to fully charge in less than 4.5 hours via Clover USB wall charger or with Clover Mobile Dock.

# Get to know Clover Mobile

## Front

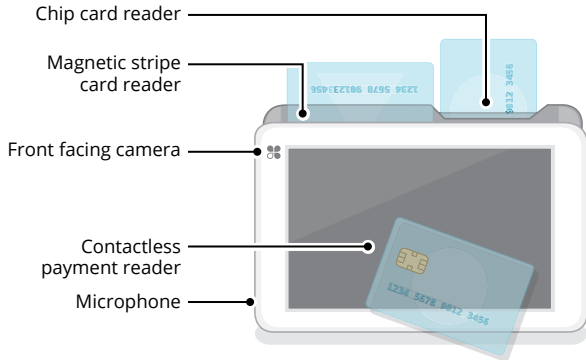

## Back

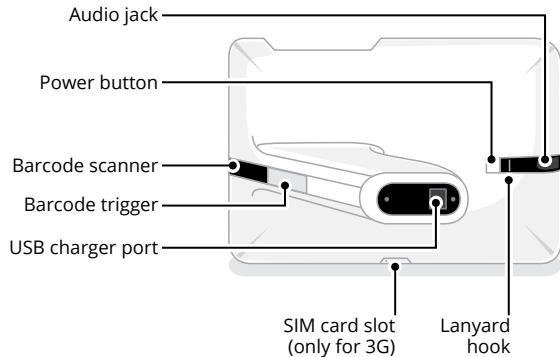

# Set up your Clover Mobile

Video set up: [clover.com/setup](https://clover.com/setup)  
Europe: [eu.clover.com/setup](https://eu.clover.com/setup)

- 1 Plug USB wall charger into USB charger port and power source
- 2 **(Only for 3G)** Open SIM card tray using SIM door eject pin through the hole. Pick the SIM card tray size that matches with your SIM card. Place card on tray and push SIM door closed.

A SIM card tray must **always** be inserted, even if you're not using a SIM card.



- 3 Press power button to turn on Clover Mobile

## Back

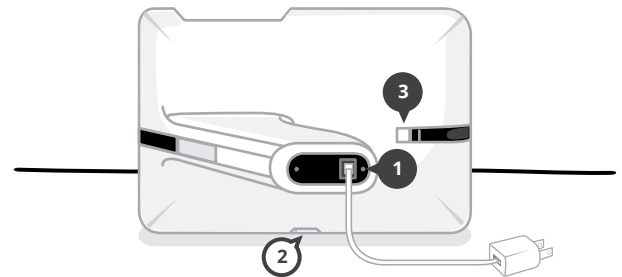

For more pairing options visit [clover.com/setup](https://clover.com/setup).

# Recommended Usage

## Hand Holding Position

Clover Mobile can be held in many ways. We recommend holding with your non-dominant hand (resting on your wrist) for optimal range of motion for card acceptance and precision tapping on the screen. For correct fit, make sure your pointer finger is located on the barcode trigger.

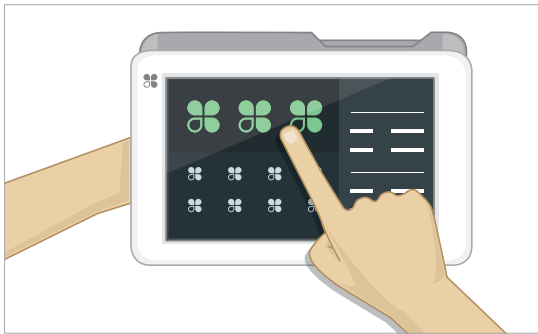
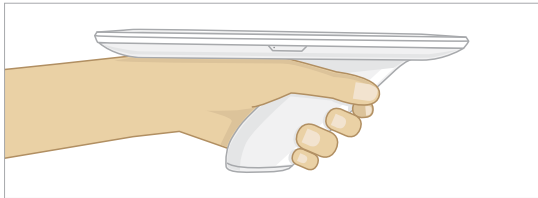

## Secure PIN Entry

Customers need to cover their PIN Entry with their hand.

PCI PTS security guidelines:  
[clover.com/setup](https://clover.com/setup)

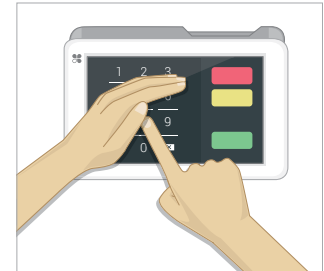

*The Clover Mobile device is PCI PTS approved as a handheld device, and is not provided with a privacy shield. Use of this device to capture a cardholder's PIN while in a fixed position - such as on a counter or in a dock - requires use of the PIN shield to ensure privacy during PIN entry and continued PCI PTS approval.*

## Clover Clip

Slide Clover Clip into apron or pant pocket for convenience.

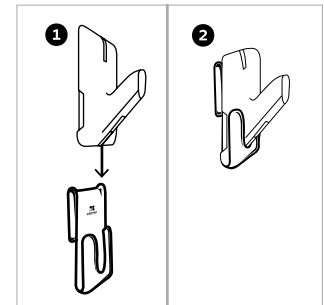

## Payment Methods

### Chip Card



### Magnetic Stripe Card



Swipe Card



Insert Card  
(chip card only)

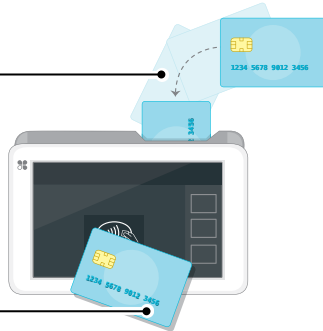

Tap Card  
(contactless card only)

## Table Placement

Landscape orientation allows full range of motion for card acceptance. If your main use case is stationary on a table, it is recommended to pair your Clover Mobile with Clover Mobile Dock for added security.

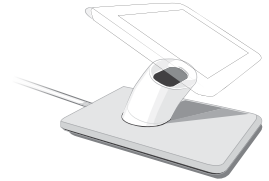

## Barcode Scanning

Ensure you are in an app where scanning can be performed. Optimal barcode scanning range: 4-12 inches (10cm-30cm).

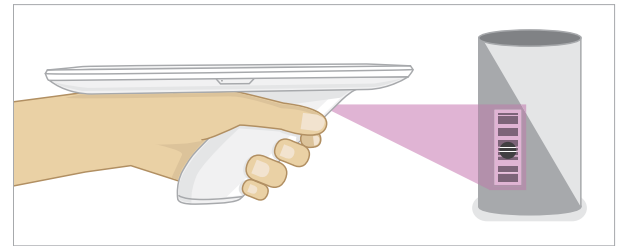

## Clover Mobile Scenarios

### Around Store



Take card payments at the counter or around the store.



Utilize the barcode scanner to manage your inventory: add new items, find items, and update stock counts in the Inventory app.



Quickly scan items by barcode to build an order in the Register app.

### Outside Store



Let customers split their bill and pay with credit or debit card securely in an outdoor setting.



Take follow-on orders when customers are already seated.



Take orders when the line goes out the door.

## Applications



### Setup Wizard

#### Let's Get Started

This is your guide for setting up Clover Mobile. Your activation code is in your welcome email.



### Home

Use your Clover Home screen for quick access to all your Clover apps. Employees can also log in and out from here.



### App Market

#### Custom Business Solutions

Browse and install apps to fit your store's every need.



## Useful Resources



### Web Access

#### Manage Your Apps

Some apps allow you to access them via your web browser. We've put shortcuts to these web pages at [clover.com/home](https://clover.com/home).

Please use Chrome, Safari, or Firefox.

In Europe, visit [eu.clover.com/home](https://eu.clover.com/home)



### Need Help?

Visit [help.clover.com](https://help.clover.com), use the Help app, or call us anytime at the phone number given in your welcome email.

